



# Tallenes Trigon

talforståelse

matematikens sprog

Hvad hedder det?  
Jeg siger... otte

nissesprog   
hverdagsprog 

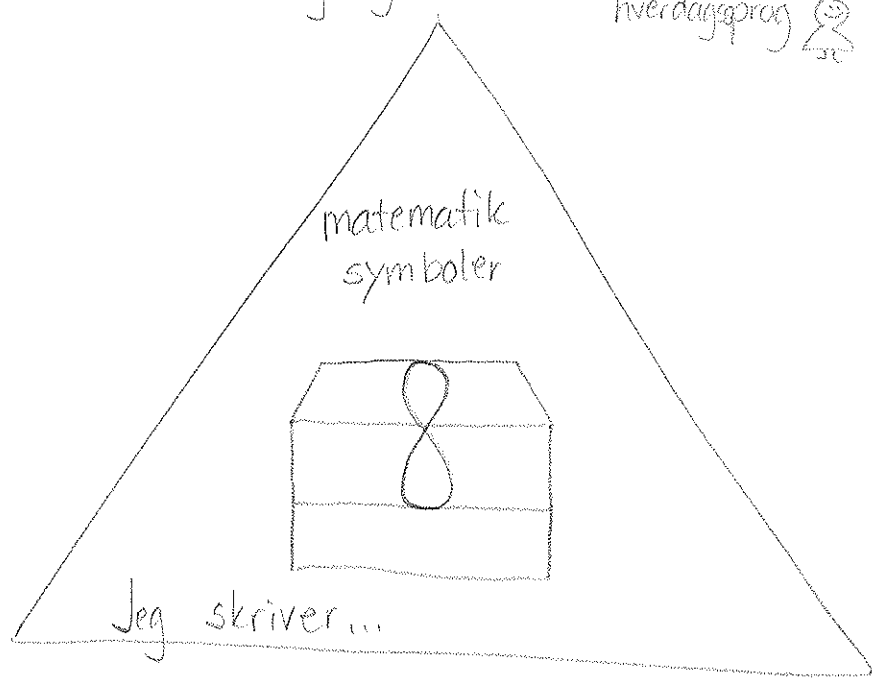

Numerisk rækkefølge  
Hvor er det henne?

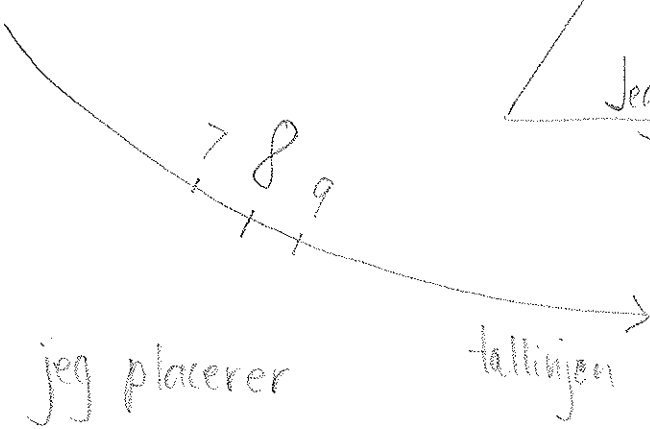

frem/tilbage

Mængde-antal  
Hvor meget er der?  
Jeg viser...

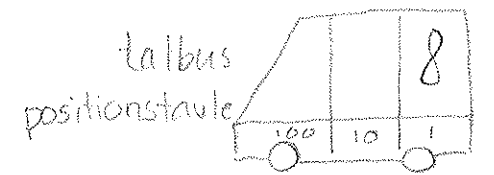

skille/samle

# Tallenes Trigon

addition - små tal

syr plus otte er en ti fem  
femten

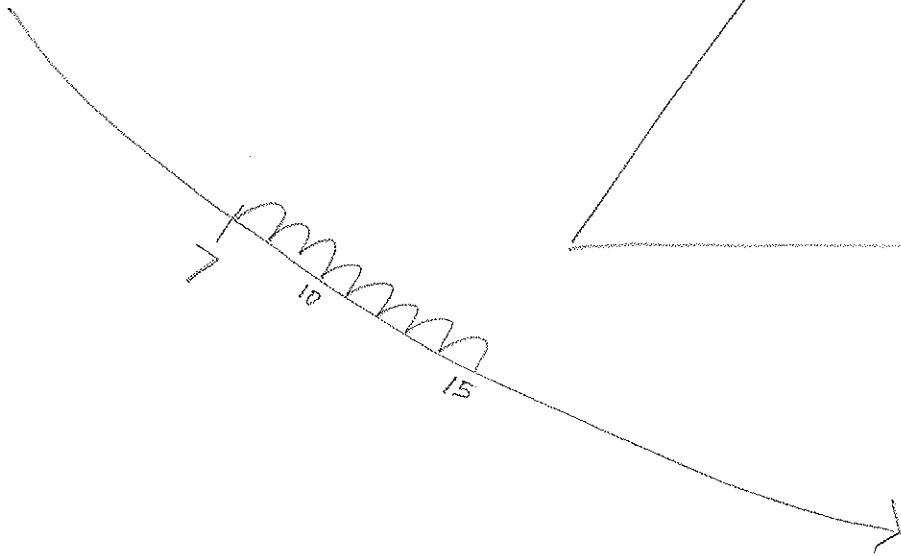
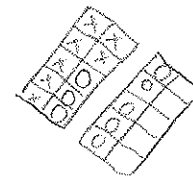
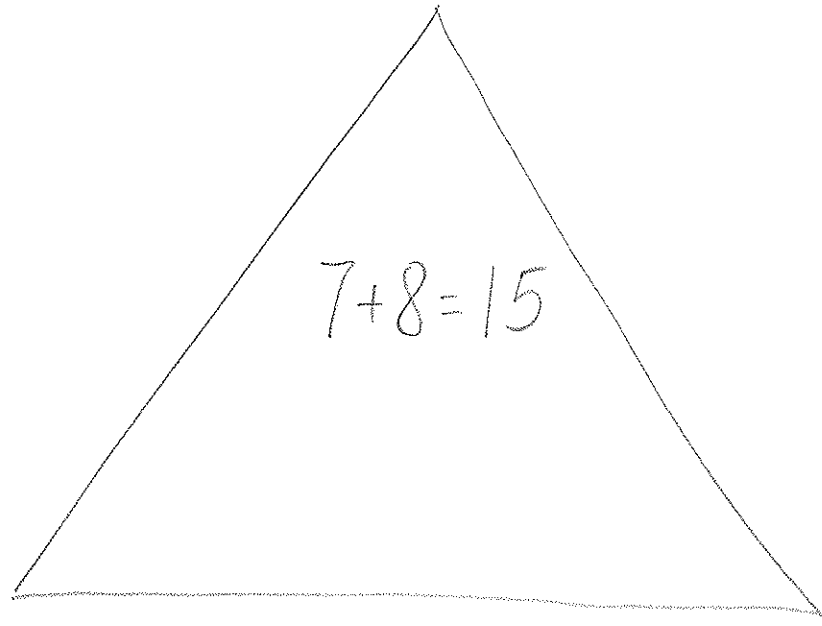

# Tallenes Trigon

addition - store tal

tre hundrede og seks og firs  
tre hundrede og otte tiseks

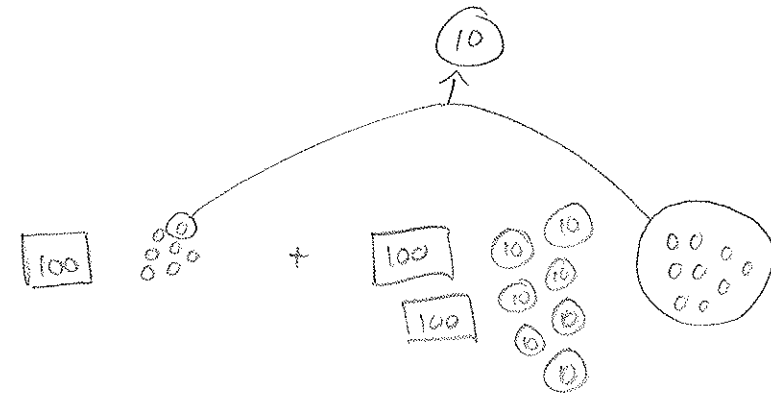
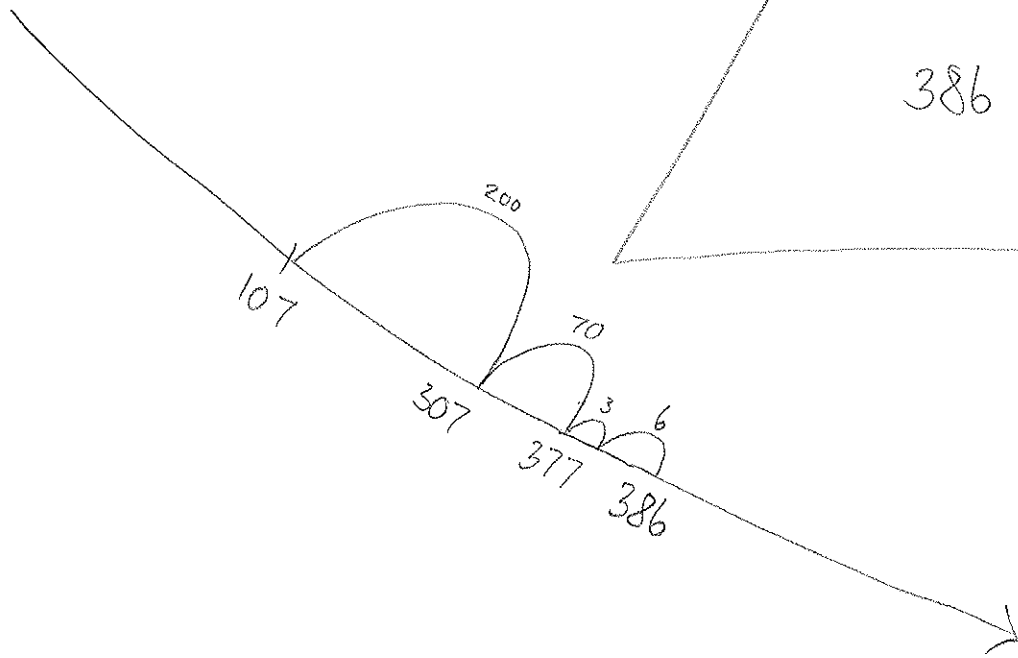
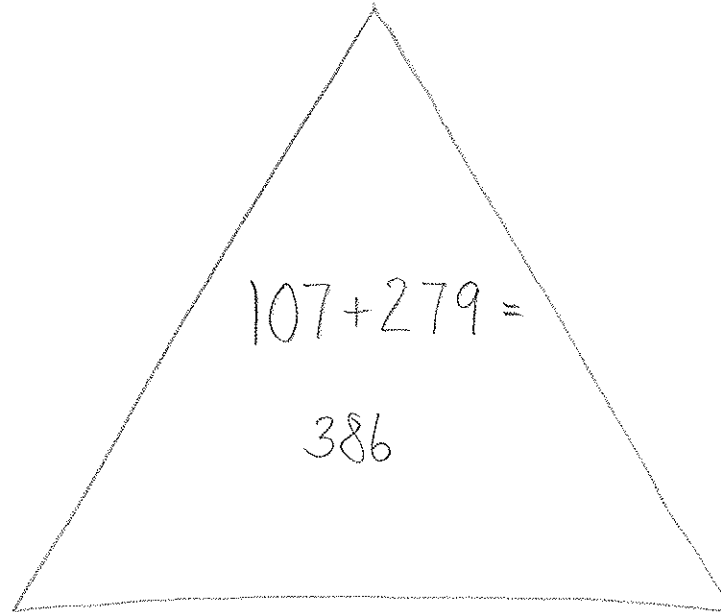

udvidet form:

$$100 + 7 + 200 + 70 + 9$$

# Tallenes Trigon

subtraktion - små tal

elleve minus fire er syv  
forskellen mellem elleve og fire er sy

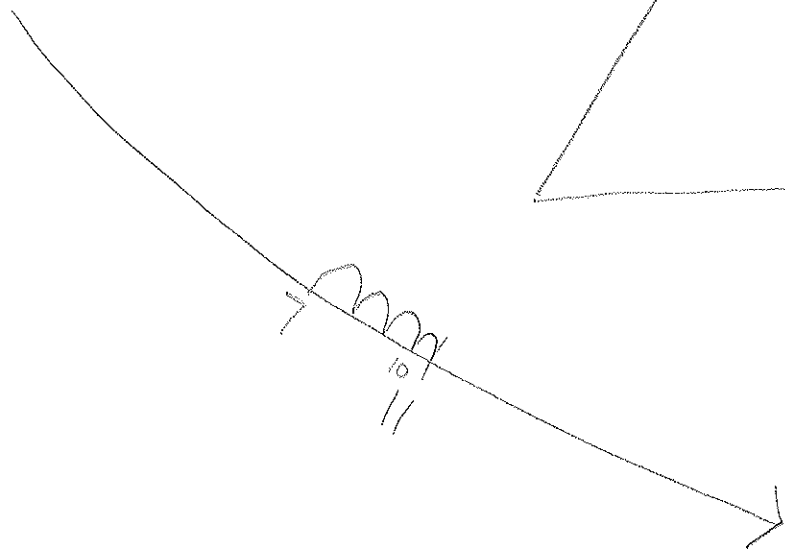
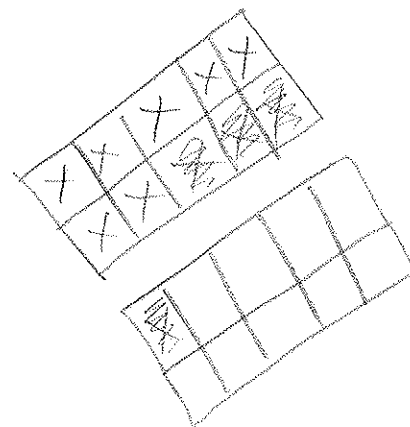
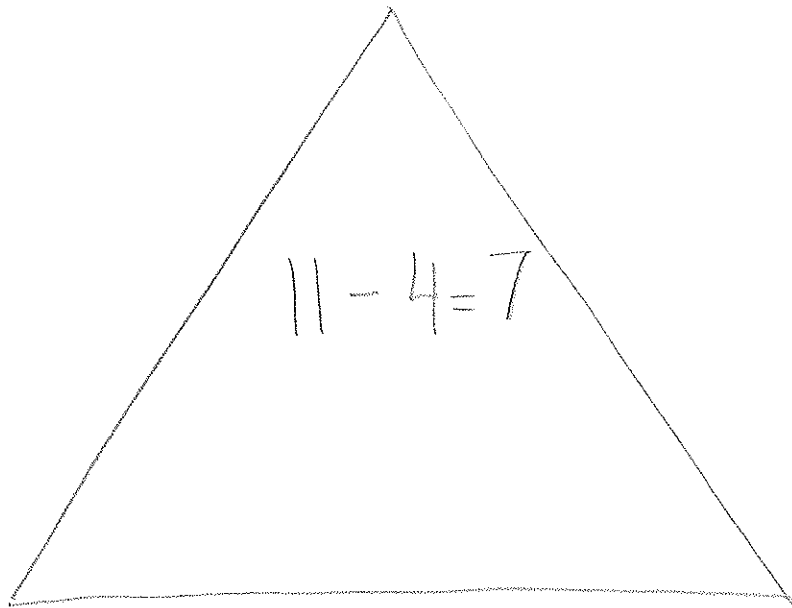

# Tallenes Trigon

subtraktion - store tal

tretten

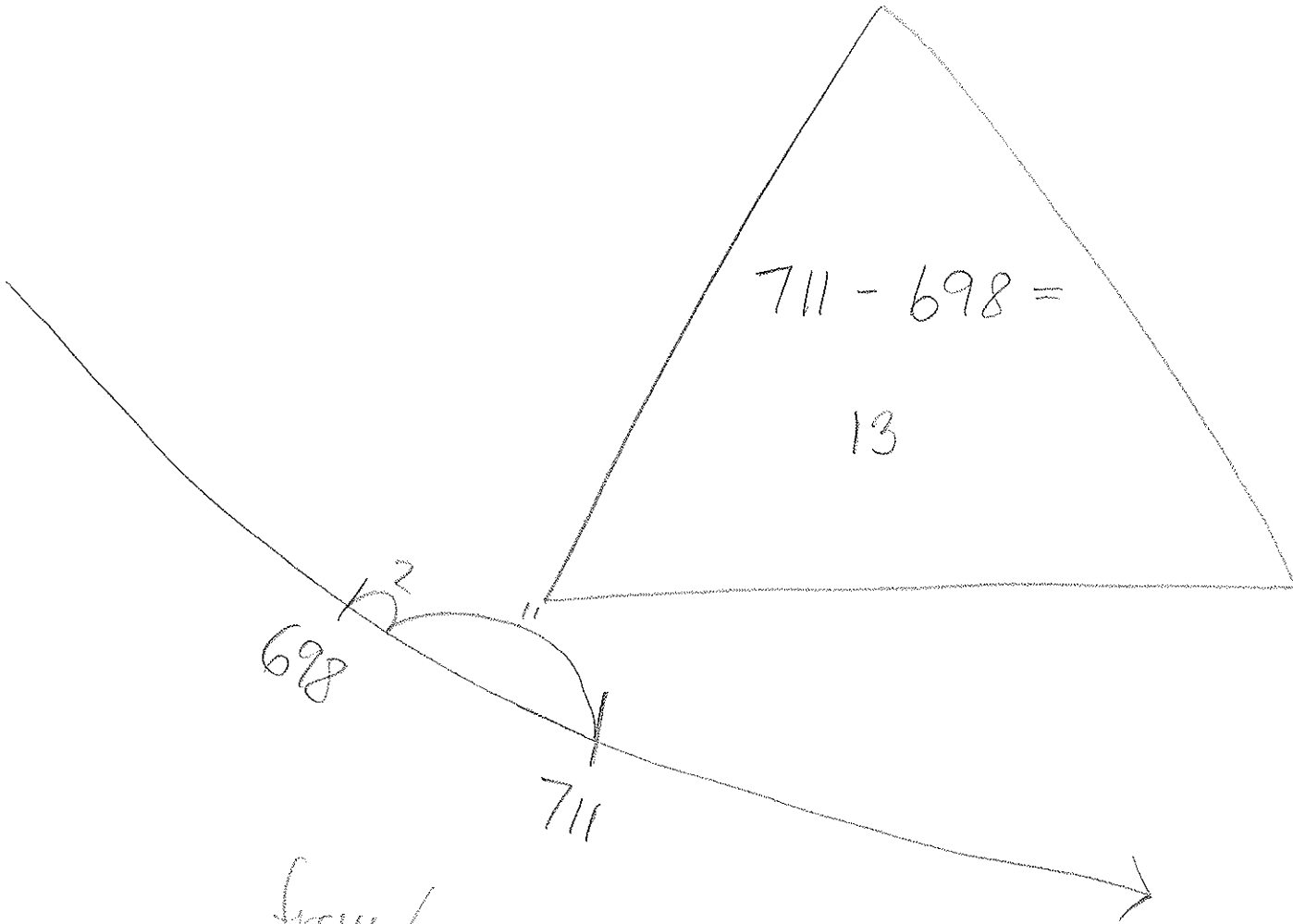

$$700 + 11 - 698$$

from / tilbage

skille / samle

Tallevens trigon  
multiplikation

seks og halvtreds  
femtiseks

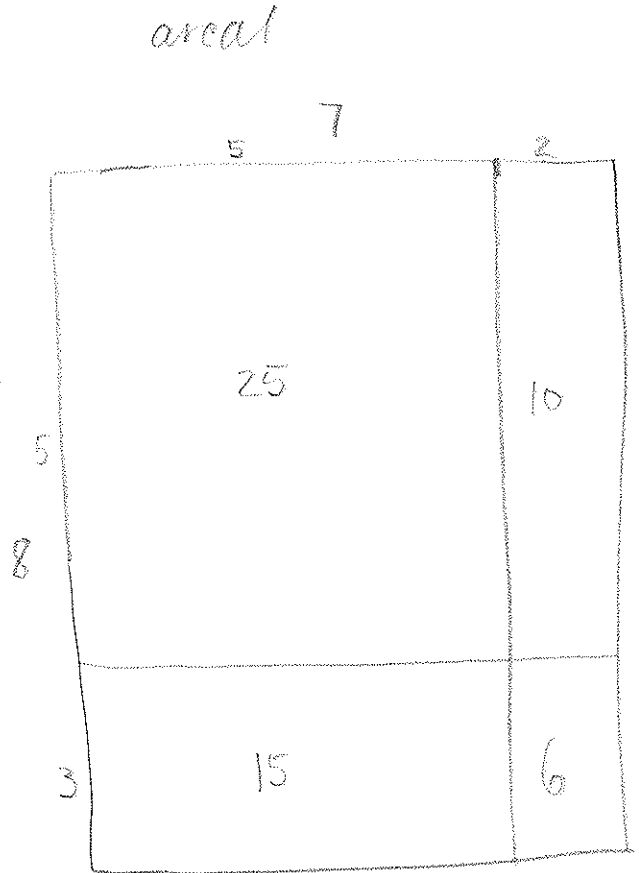
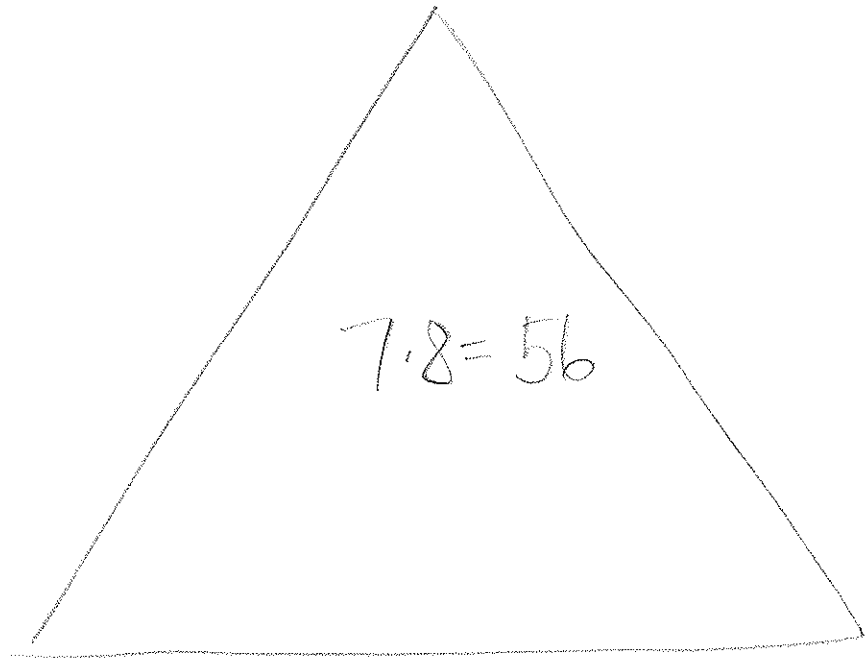
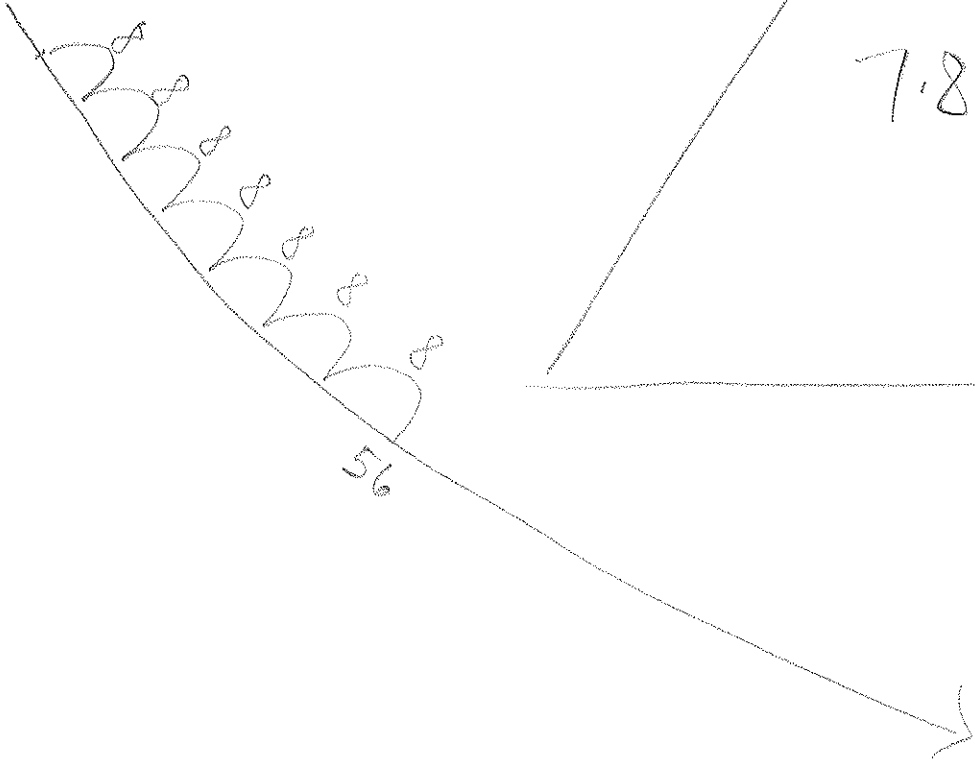

# Tallenes Trigon

## Division

$$\begin{array}{r} 732 \\ \hline 7 \\ \hline 104 \text{ rest } 4 \end{array}$$

~~$$732 \quad 32 \quad 4$$~~

de 7  
↓



$$100 + 4 + 0$$



$$100 + 4 + 0$$



$$100 + 4 + 0$$



$$100 + 4 + 0$$



$$100 + 4 + 0$$



$$100 + 4 + 0$$



$$100 + 4 + 0$$

rest 4

Talletes trin  
rationelle tal

Kommer adskiller hele og brøkkede dele i et tal.

syv tusind tre hundrede et-ti otte komma seks tiendedele to hundredtedele

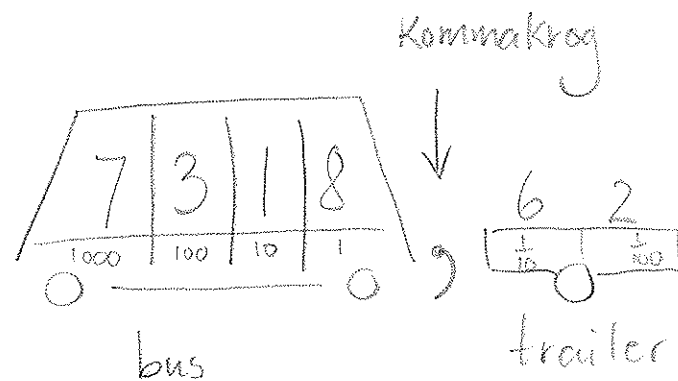
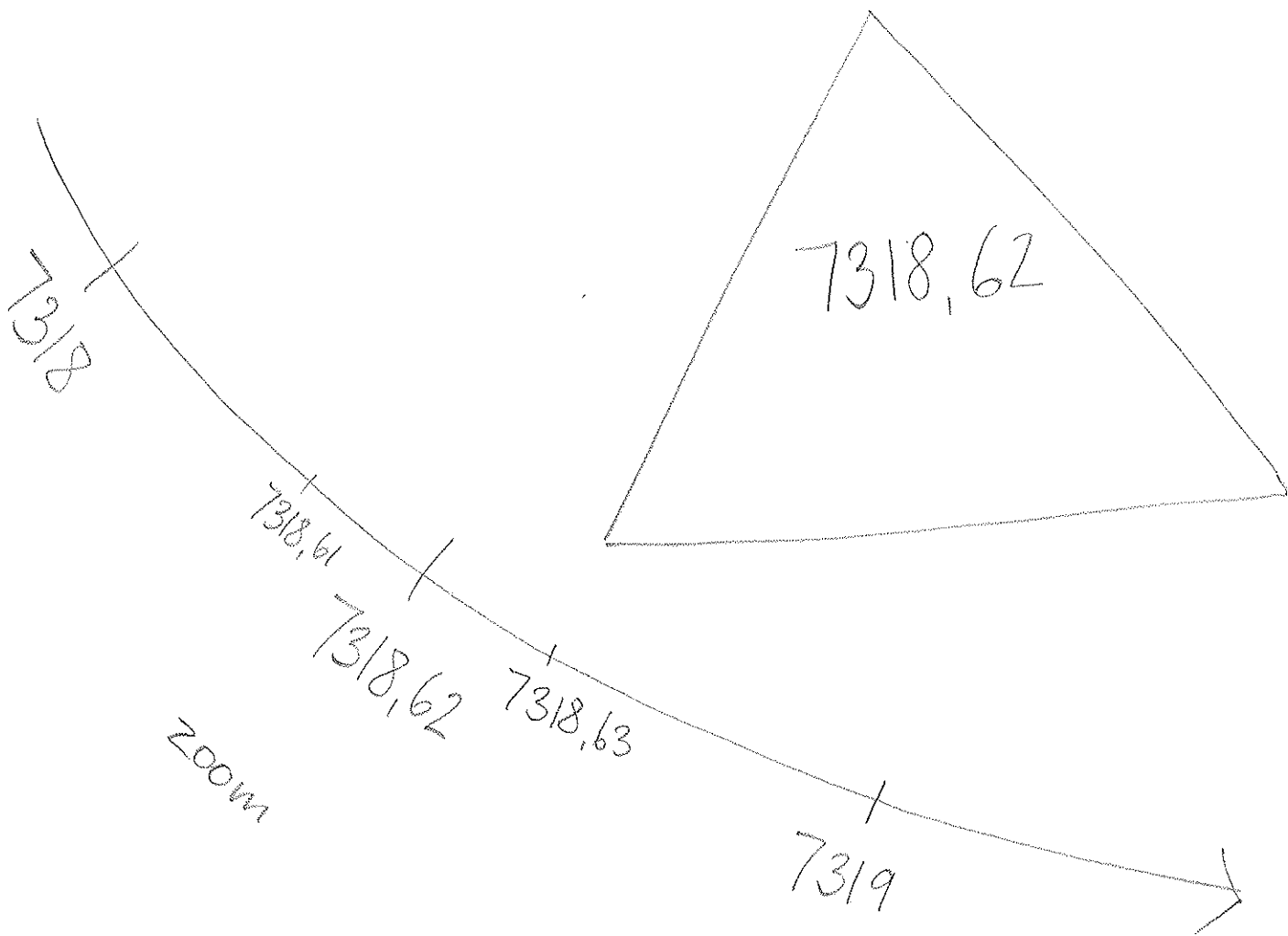



# Tallenes Triagon

multiplikation - store tal

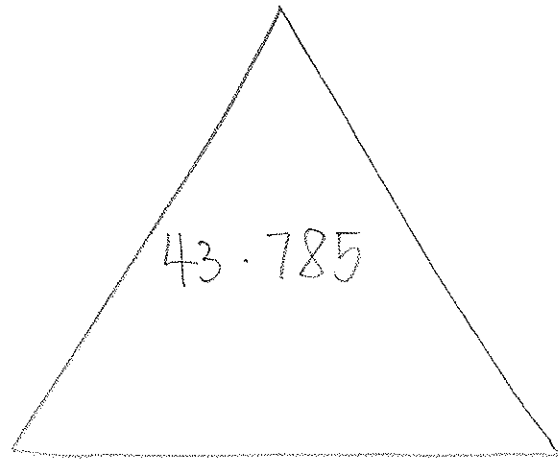

785

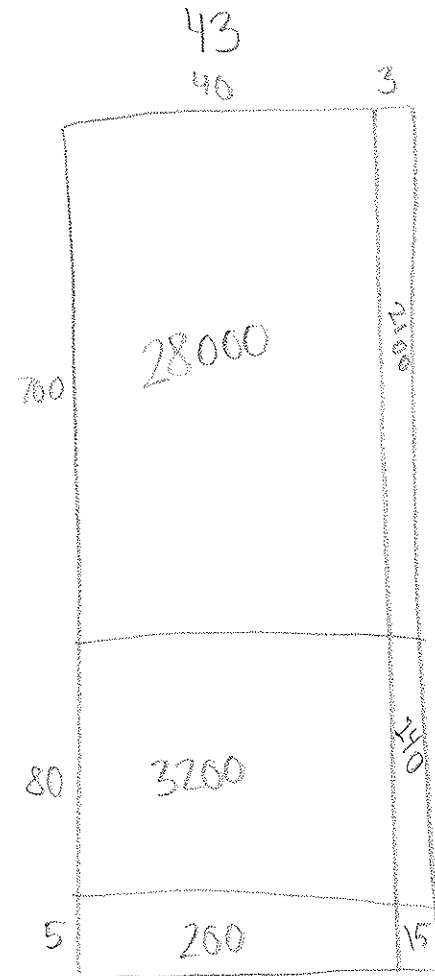

$$28000 + 5300 + 440 + 15 = 33755$$

# Tallenes Trigon Tid

seksogtyve minutter i et  
tolv fire og tredive  
fire minutter over halv tolv

